

portablespace

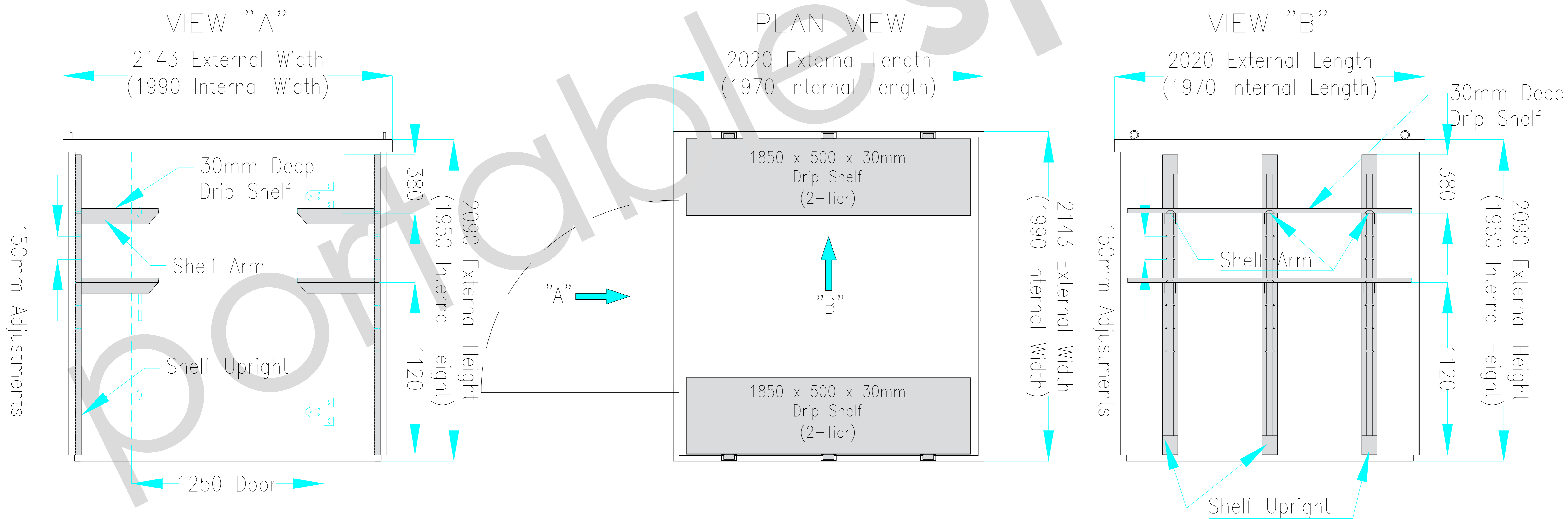

Unit 1, Red House Farm Business Units, Bacton, Suffolk, IP14 4LE
 Tel: 01449 782123
 Fax: 0845 3311434

Copyright in this drawing belongs to Portable Space Ltd. Neither the whole drawing nor any part thereof may be reproduced without the prior permission in writing of Portable Space Ltd

DRAWING STATUS	
1	<input checked="" type="checkbox"/> PRELIMINARY (FOR INFORMATION ONLY)
2	<input type="checkbox"/> CLIENT APPROVED
3	<input type="checkbox"/> ISSUED FOR MANUFACTURE
4	<input type="checkbox"/> AS BUILT
COLOUR: RAL TBC	
OVERALL CAPACITY (M3):	*
UNLADEN WEIGHT (KG)	*
MAXIMUM LADEN WEIGHT (KG)	*
MAXIMUM LIFT WEIGHT (KG)	*

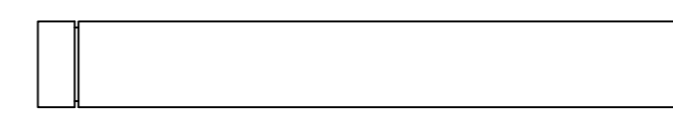
Shelf Arm 

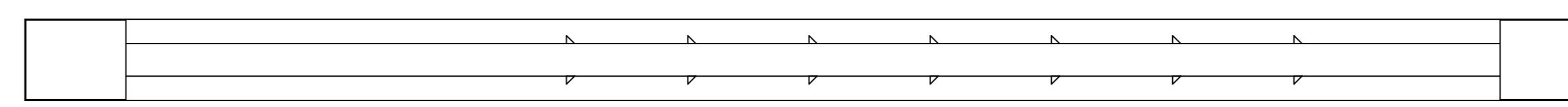
Shelf Upright 

Shelf Sizes

Long Shelf – 1850 x 500 x 30mm
 Short Shelf – 1370 x 500 x 30mm

30mm Deep Drip Shelf

Additional Details
 Please Note:

- Each Arm is Rated to hold 15kg per arm
- Each Upright can support maximum of 3 drip shelves
- 150mm Adjustment on Shelf Uprights

Title		
PORTABLE SPACE LTD: 2M FLAT-PACK STORE C/W 2-TIER SHELVING (2 SIDES)		
Unit Type		
2M FLAT-PACK STORE UNIT		
Date	Scale	Drawn By
19-05-20	N.T.S	LG
Q No.	Drawing No.	Rev.
*	*	0
Revision Details:		
*		