



Flat Pack Store

instructions and accessories



CONTENTS

| | |
|---|-----------|
| 1. Flat Pack Store – Assembly Instructions | 2 |
| 2. Linking Stores – Side by Side and End on End Linking Kits | 6 |
| 3. Locking Bar – Assembly Instructions | 11 |
| 4. Shelving – Assembly Instructions | 13 |

1. Flat Pack Store

ASSEMBLY INSTRUCTIONS

For assembling 2m, 3m, 4m and 6m stores (standard and XL)



Tools and equipment you will need:

- PZ2 screwdriver
- Flat head screwdriver
- 13mm spanner
- 19mm spanner and socket set
- Spirit level
- Five tread stepladder (minimum)
- Work gloves (to protect your hands from sharp edges and to assist grip when lifting the metal panels)

Please refer to the Risk Assessment 'Erection of Flat Pack Stores'.

A minimum of two people are needed to assemble the store. If parts need to be moved by hand, we recommend using four people to allow for one person at each corner.

Web Quick Find (QF Code):

STORES (the actual container itself)

- 2m GALVANISED QF243
- 2m GREEN QF245
- 3m GALVANISED QF249
- 3m GREEN QF251
- 4m GALVANISED QF255
- 4m GREEN QF257
- 6m GALVANISED QF270

STORES BUNDLES

- 3m x 4.2m GALVANISED (2 x 3m stores side linked) QF975
- 3m x 4.2m GREEN (2 x 3m stores side linked) QF971
- 6m x 2.1m GALVANISED (2 x stores end linked) QF976
- 6m x 2.1m GREEN (2 x stores end linked) QF972
- 4m x 4.2m Side Linked GALVANISED QF977
- 4m x 4.2m Side Linked GREEN QF973
- 8m x 2.1m End Linked GALVANISED QF978
- 8m x 2.1m End Linked GREEN QF974
- 6m x 4.6m Side Linked GALVANISED QF280
- 12m x 2.3m End Linked GALVANISED QF281

Components for 2m, 3m, 4m and 6m stores

Store 2m 271kg

CONTAINER PARTS

| | |
|---------------------------|---------|
| Container Rear Panel 30kg | 1 Piece |
| Container Side Panel 26kg | 2 Piece |
| Door Panel 51kg | 1 Piece |
| Door | 1 Piece |
| Container Roof 50kg | 3 Piece |
| Container Chassis 88kg | 1 Piece |

HARDWARE PARTS

| | |
|--------------------------|----------|
| M5 Nut | 2 Piece |
| M5 Washer | 2 Piece |
| M8 x 25mm Bolt | 28 Piece |
| M8 Nut | 22 Piece |
| M8 Washer | 44 Piece |
| Brass Door Handle | 2 Piece |
| Countersunk M5 x 50 Bolt | 2 Piece |
| Barrel With Key | 2 Piece |
| M12 Washer | 18 Piece |
| M12 x 40mm Bolt | 4 Piece |
| M12 Nut | 4 Piece |
| Hinge | 2 Piece |
| M12 x 25 Bolt | 14 Piece |
| M10 Nut | 14 Piece |
| M10 Washer | 14 Piece |

Store 3m 351kg

CONTAINER PARTS

| | |
|---------------------------|---------|
| Container Rear Panel 30kg | 1 Piece |
| Container Side Panel 40kg | 2 Piece |
| Door Panel 51kg | 1 Piece |
| Door | 1 Piece |
| Container Roof 70kg | 3 Piece |
| Container Chassis 120kg | 1 Piece |

HARDWARE PARTS

| | |
|--------------------------|----------|
| M5 Nut | 2 Piece |
| M5 Washer | 2 Piece |
| M8 x 25 mm Bolt | 30 Piece |
| M8 Nut | 22 Piece |
| M8 Washer | 46 Piece |
| Brass Door Handle | 2 Piece |
| Countersunk M5 x 50 Bolt | 2 Piece |
| Barrel with Key | 2 Piece |
| M12 Washer | 4 Piece |
| M12 x 40 mm Bolt | 4 Piece |
| M12 Nut | 4 Piece |
| Hinge | 2 Piece |
| M12 x 25 Bolt | 14 Piece |
| M10 Nut | 14 Piece |
| M10 Washer | 14 Piece |

Store 4m 421kg

CONTAINER PARTS

| | |
|---------------------------|---------|
| Container Rear Panel 30kg | 1 Piece |
| Container Side Panel 54kg | 2 Piece |
| Door Panel 51kg | 1 Piece |
| Door | 1 Piece |
| Container Roof 79kg | 3 Piece |
| Container Chassis 153kg | 1 Piece |

HARDWARE PARTS

| | |
|--------------------------|----------|
| M5 Nut | 2 Piece |
| M5 Washer | 2 Piece |
| M8 x 25 mm Bolt | 32 Piece |
| M8 Nut | 22 Piece |
| M8 Washer | 48 Piece |
| Brass Door Handle | 2 Piece |
| Countersunk M5 x 50 Bolt | 2 Piece |
| Barrel with Key | 2 Piece |
| M12 Washer | 4 Piece |
| M12 X 40 mm Bolt | 4 Piece |
| M12 Nut | 4 Piece |
| Hinge | 2 Piece |
| M12 x 25 Bolt | 14 Piece |
| M10 Nut | 14 Piece |
| M10 Washer | 14 Piece |

Store 6m 850kg

CONTAINER PARTS

| | |
|----------------------------|---------|
| Container Rear Panel 35kg | 1 Piece |
| Container Side Panel 267kg | 2 Piece |
| Door Panel 82kg | 1 Piece |
| Door | 1 Piece |
| Container Roof 160kg | 3 Piece |
| Container Chassis 306kg | 1 Piece |

HARDWARE PARTS

| | |
|--------------------------|----------|
| M5 Nut | 2 Piece |
| M5 Washer | 2 Piece |
| M8 x 25 mm Bolt | 32 Piece |
| M8 Nut | 22 Piece |
| M8 Washer | 48 Piece |
| Brass Door Handle | 2 Piece |
| Countersunk M5 x 50 Bolt | 2 Piece |
| Barrel with Key | 2 Piece |
| M12 Washer | 4 Piece |
| M12 X 40 mm Bolt | 4 Piece |
| M12 Nut | 4 Piece |
| Hinge | 2 Piece |
| M12 x 25 Bolt | 14 Piece |
| M10 Nut | 14 Piece |
| M10 Washer | 14 Piece |

Note: 6m XL Flat Pack Stores

Assembly of 6m stores the same as all other stores in the flat pack range. However due to the larger size and weight of the components (the floor and roof) it requires mechanical assistance from typically a crane or forklift for moving component parts and fitment of the roof. Parts others than the floor and roof can still be moved by hand if necessary, but typically require 4-6 people to do so.

The 6m chassis unlike the smaller stores is fitted with forklift pockets that enables safe lifting with a forklift, these pockets can also be used for lifting from above with straps fed through each fork tunnel. The roof is fitted with 4 lifting points for lifting from above with small chains or straps. However if you only have a forklift available and no access to straps please order the 6m flatpacked store roof forklift attachment QF290. This simply bolts to the usual lifting points and enables the roof to be safely lifted and positioned using forklift tines. The forklift pockets are then removed and the lifting points refitted once erected. Alternatively units can be bought ready assembled.

Assembly hints

- 1.1 Try to get the pack delivered as close as possible to the erection area. If it arrives on one of our HIAB lorries, please let the driver know and they will help by levelling it up with you. To ensure the chassis is level, it's best to use each of the four corners and once level support the base in the middle to help prevent any sag over time.
- 1.2 Ideally concrete bases are the best option for long-term installations although paving slabs can provide the simplest solution. Plywood packing is ideal for small adjustments or short/medium-term installations.
- 1.3 The erection process is made much easier when the chassis is level at the start.
- 1.4 Don't assemble in windy conditions as this can be dangerous and make sure you have enough people available to move and erect the panels safely.

Maintenance

- 1.5 Check foundations periodically to make sure that the unit remains level. Signs that the unit might have moved usually result in the door becoming difficult to open or close, or the unit rocking on the pads.
- 1.6 The only moving parts are the lock and hinges which need a light oiling on a periodic basis.
- 1.7 Check the roof from time to time and remove any debris, especially leaves, to ensure the gutters work correctly.

Other information

- 1.8 If you keep all the packaging material, it can be used to re-pack the unit at a later date. Otherwise please recycle it.
- 1.9 The unit is not designed to be stacked.
- 1.10 The unit once correctly assembled, can be lifted and moved using the lifting hooks. Please check the security of all fixings each time before lifting.

Delivery and unpacking

- 1.11 The store will arrive in flat pack form. If the crane can offload and level up in the final erection position, this will save you time later.



- 1.12 Whether or not you need to move the parts to a different location, the store now needs to be unpacked. Unbolt the four metal retaining plates using a 19mm spanner and also unscrew the lifting eyes. The retaining plates are not required for assembly, so dispose or keep if you intend to re-pack the unit at a later date.



- 1.13 Now lift off the top roof panel and all other items. Lay them out neatly so you can easily locate the parts later. Please do not attempt this in windy or gusty conditions as individual parts could be blown away, endangering you and others.

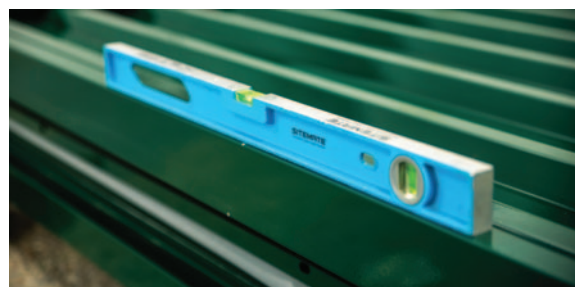

- 1.14 If you need to move the parts to a new location, do so now. Begin with the base which needs to be level (check with the spirit level), before starting the erection process.

Erection of the flat pack store



- 1.15 Position the door panel on the end required.
- 1.16 Using a 13mm socket now fit 4x M8 bolts and washers to secure the door panel to the chassis.



- 1.17 Fit locks into the door panel, slide the barrels into the door and turn. Once the lock turns, this shows it is located correctly and the screw can be inserted and tightened using your PZ2 screwdriver.



- 1.18 Now unlock the door and prop it open using the wooden packaging that you removed earlier. If you are erecting on an exposed site, you may need others to hold the door panel to prevent it falling and causing damage.

- 1.19 Now lift either wall panel (if the site is restricted we recommend you start with the wall nearest any obstruction) to the side of the chassis base. The tongue on the side panel will slide into a groove on the door panel. Once aligned correctly, fix the wall panel to the door panel using an M8 bolt with washer each side.

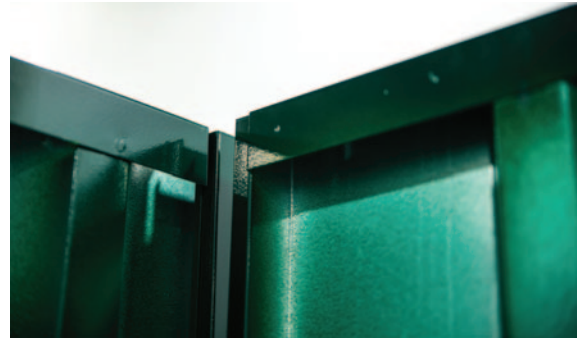

- 1.20 Now fix the side panel to the chassis using 3x M10 and 2x M8 bolts and washers.
- 1.21 Repeat steps 1.19 – 1.20 for the other side panel.



- 1.22 Now fit the end panel (panel opposite the door). Rest on the bottom of the chassis rail at 45 degrees and raise up, aligning the tongue and groove joints as you lift. Do not force this as it could damage the tongue, making it difficult to align correctly later. Secure to chassis and side panels as per other panels.



1.23 Next fit the roof panel, making sure the ID plate is at the door end. You may need additional helpers at this point. Firstly close and lock the door, and assuming site conditions allow, lift the roof onto the door panel and slide up. Once the roof panel is in the correct place it will slot over all four walls. Please keep fingers clear at this point as it can lock down unexpectedly. If necessary the panel can be slid up from the side but due to steeper angles this requires more effort. For 6m stores – see note on page 3.

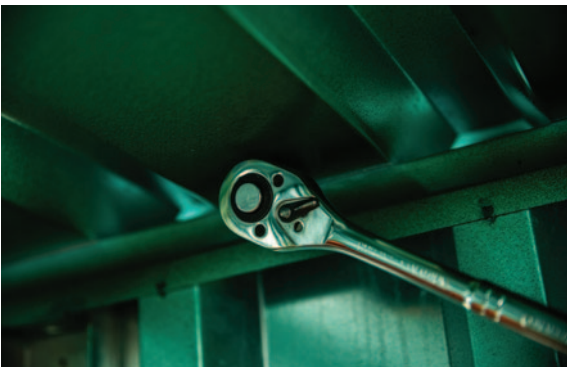

1.24 Now fit the 4x M8 bolts and two washers to secure the roof to the respective wall panels.



1.25 Using your stepladder, access the top of the roof to screw in the 4x lifting eyes.



1.26 Fit the handles onto the inside and outside of the door using the screws provided.

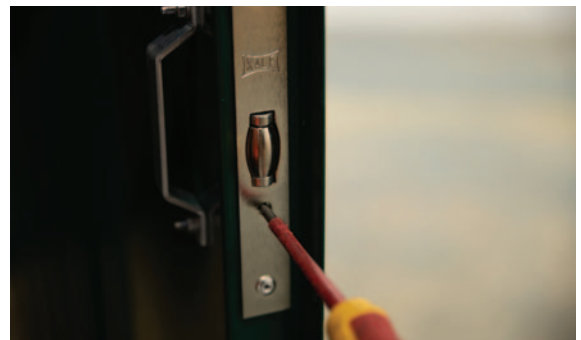

1.27 Finally adjust the ball catch using the PZ screwdriver so that the door closes easily but remains in position when unlocked. Clockwise brings the ball out and anticlockwise pushes it in again.





2. Linking Stores

ASSEMBLY INSTRUCTIONS

For any 2m, 3m, 4m and 6m XL stores

Tools and equipment you will need:

- Cross-head screwdriver
- Flat head screwdriver
- 13mm spanner
- 19mm spanner and socket set
- Spirit level
- Work gloves (to protect your hands from sharp edges and to assist grip when lifting the metal panels)



Parts for side by side linking kit:

- 4 x bolts M12
- 4 x Steel washers
- 4 x M12 nuts
- 4 x Rubber sealing gaskets

Web Quick Find (QF Code):

2m Side Link GALVANISED QF598
2m Side Link GREEN QF576
3m Side Link GALVANISED QF594
3m Side Link GREEN QF591
4m Side Link GALVANISED QF595
4m Side Link GREEN QF592
6m XL Side Link GALVANISED QF590

Side by side linking kit assembly



- 2.1** Plan where you intend to erect the two containers. You will need to support each container with at least six pads rather than the minimum pads when linking side by side (depending on location and planned use you may need more). Follow usual assembly instructions for the first container, but leaving the side panel off on the side that you plan to link and DO NOT fit the roof section.

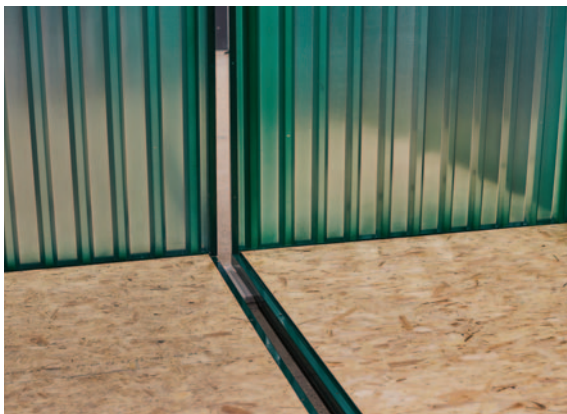

- 2.2** Once you have prepared the first container you can then start assembly of the second container in the usual way on the required side, leaving the side panel off position the second base (also with a minimum of six pads) with a gap between the side rails of 85mm. Both containers must be completely level, you can check this using a spirit level making sure that the gap at the top and bottom of the end panels is the same.



- 2.3** Gap between the two containers being joined.



- 2.4** Now fit both roof panels in the normal way, ID plates facing towards the outside ends.

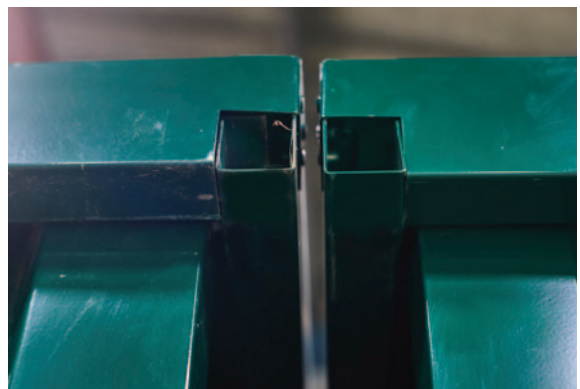

- 2.5** View between the two roof sections, showing gutter.



2.6 Now fit the galvanised internal roofing strip – from the inside push the galvanised roofing strip up into the roof, then raise up the opposite end until the bolt holes match up. One person will then need to access the roof to fit the 4 x M12 bolts with the waterproof black plastic washer on the outside. The steel washer and nut will be fitted from the inside.



2.7 Fit galvanised roof strip from the inside.



2.8 Secure with bolts from above and use the rubber washers on outside.



2.9 Secure with nut from inside.



2.10 View of roof panels showing galvanised jointing strip in place.



2.11 Now fit the two powder coated uprights at each end – place the bottom end in first and push into place at the top. Using the 6 x M8 bolts supplied with the container (not the linking kit – normally used for joining side and end panels).



2.12 Secure joining uprights with bolts and fit the wooden floor cover as shown.

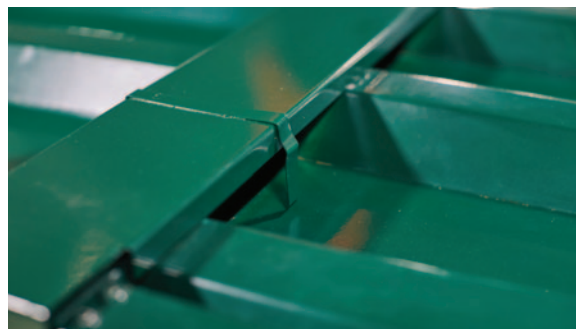

2.13 Fit the external cover strip – access the roof safely from above using your step ladder now fit the external roof cover strip, bend the metal tags to secure. You will have two side panels surplus to requirement.

End on end linking kit assembly



Parts for end on end linking kit:

- 12 x M8 bolts
- 12 x M8 Nuts
- 24 x M8 washers

Web Quick Find (QF Code):

(Same on all stores)

Standard End Link GALVANISED QF583

Standard End Link GREEN QF582

XL End Link GALVANISED QF599



- 2.14** Erect first container as per normal, leaving off either the rear door of rear end (this configuration can be fitted with doors at both ends or door at one end and panel at opposite end. Unless you have enough people power available to support side panels we suggest that you consider securing the side panels together with a timber batten to prevent damage until you are ready to fit the link.



- 2.16** 100mm gap between the bases (165mm between wall panels).



- 2.15** Now erect the second container, allowing a gap of 165mm between the fixing points on the side panels on each container OR 100mm between the bottom rails (on the base of the container). Both containers must be level with each other.



- 2.17** Fit the two side joining panels, someone will need to safely access from above using work platform or suitable step ladder, slide each joining strip down from above locating in the slots and fit with 6 x M8 bolts.



2.18 Fit Side joining strip from above.



2.21 Slide roof panels up from either end, the ID plates on each roof should be facing outwards.



2.19 Secure side panels with M8 bolts.

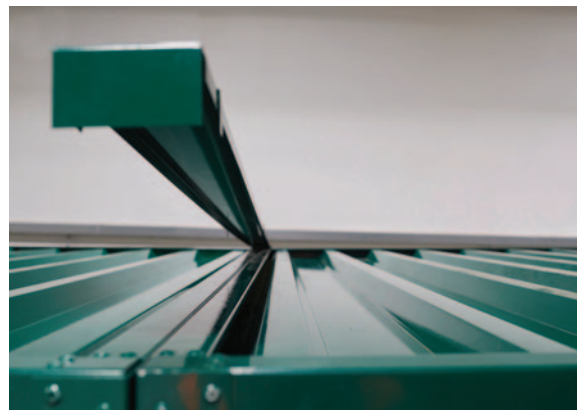

2.22 Fit powder coated external roof strip between the roof panels.



2.20 Place the wooden floor strip between the containers.

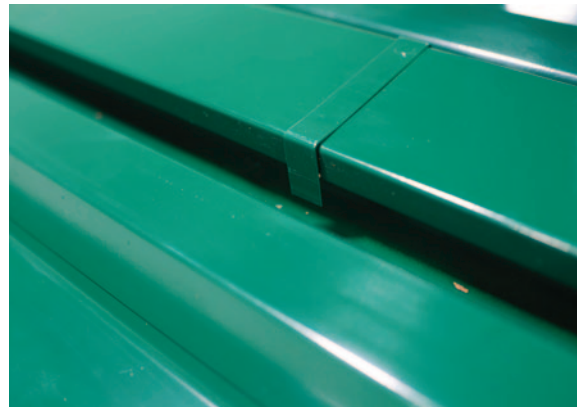

2.23 Bend of tags to secure. You will have either one door panel and one end panel surplus, or two end panels.



3. Locking Bar ASSEMBLY INSTRUCTIONS

For any 2m, 3m, 4m Flat Pack store

Overview

The locking bar provides additional security, using 2 fixings attached to the container with security cup head bolts and a removable steel bar that prevents door being opened when padlocked.

Tools and equipment you will need:

- Cordless drill
- 12mm drill bit
- 4mm or any small drill bit for pilot hole or centre punch
- Safety glasses
- Pencil or marker pen
- Leather work gloves
- Eye protection

Parts for Locking Bar:

- 8 x 10mm coach bolts
- 8 x washers
- 8 x nuts
- 1 x padlock security plate (usually fitted to the side opposite the hinges)
- 1x locking bar security plate (usually fitted next to the hinge)

Web Quick Find (QF Code):

Standard Locking bar QF577
XL Locking bar QF571



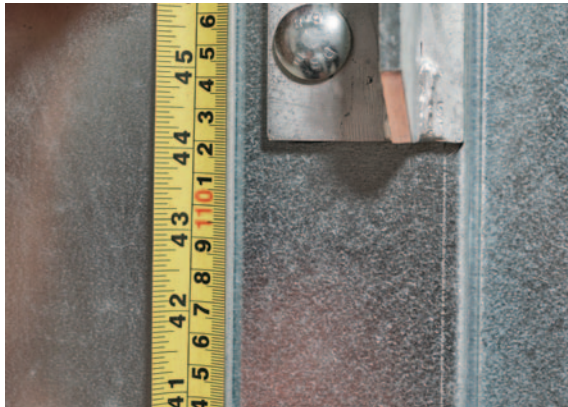

- 3.1 For extra security its possible to fit more than one locking bar.
- 3.2 The recommended position when fitting a single locking bar is above the door handle. Position the security plates 112cm from the bottom rail of the chassis to the bottom of each security plate as shown in the attached photo (although it can be fitted any height you choose, depending on expected use). The two security plates are different, one accommodates the padlock and is usually fitted the same side as the original door locks. The opposite one supports the locking bar itself (see assembled product).



- 3.3 Position the security plates so that they are the correct way round as shown in the final fitted photos
- 3.4 Mark out and centre punch (or drill pilot hole) 8 x holes (4 for left and 4 right)
- 3.5 Drill 8 x 12mm holes

- 3.6 Fit security plates using coach bolts provided (nuts on inside).



- 3.7 Mounting plate opposite padlock usually (nearest the hinges).



- 3.8 Mounting plate nearest container padlock.



- 3.9 Slide the locking bar into the door hinge end and fit padlock.

The locking bar can be used when you want extra peace of mind, please make sure you store it where it will not be a trip hazard. The bar is maintenance free, we recommend that you occasionally spray the padlock with a silicone based spray.

4. Shelving System

ASSEMBLY INSTRUCTIONS

For any 2m, 3m, 4m Flat Pack store

Overview

The Portable Space shelving system is extremely quick and easy to erect. It is made up of a minimum of two shelf uprights that slot quickly and easily into the wall of the flat pack container using no fixings. The shelf arms (also no fixings required) have a 15kg load capacity each. The shelf upright itself has a capacity of 30kgs, this means a maximum of two shelf arms can be used on each shelf upright. Therefore when using two shelf uprights each shelf has a load capacity of 30kg, with each additional shelf upright and shelf arm the load capacity increases by 15kg up to a maximum of 60kgs per shelf for both the 1370mm and 1850mm shelf sizes.

The exact contents of your kit will depend on which shelf configuration and option you have chosen but the assembly method will be the same. Before starting make sure that the flat pack container has been correctly assembled and all bolts have been used as indicated in the instruction manual.

First of all unwrap all items and lay them out so that you can plan where each shelf will be located and the height that you need to use the shelves.



Scan here for shelving system assembly instructions video



- 4.1** Insert the top of the shelf upright into the top rail of the flat pack container, these should be positioned so that the shelf will be stable and secure when loaded. Not too close to the end and wide enough apart that the shelf will be balanced. Make sure that the shelf upright is now located behind the bottom rail of the container.

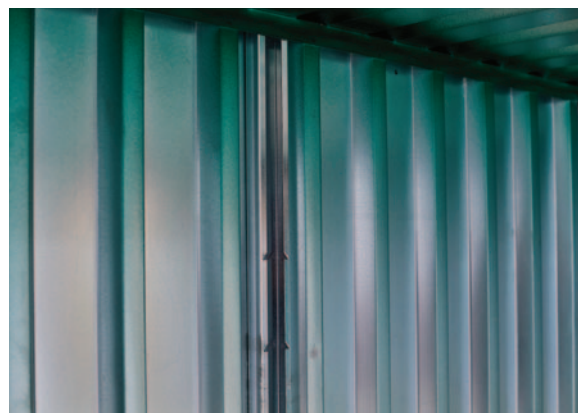

- 4.2** See above to show which end is the top.



4.3 Twist the shelf arm at around 45 degrees to enable it to slot into the shelf upright. Now twist the shelf arm, sometimes a small tap is required to locate the shelf arm into the final position. If you need to remove or reposition the shelf arm at anytime, twist the shelf arm in the opposite position and lift upwards.



4.4 Final position of shelf arm, when correctly fitted.

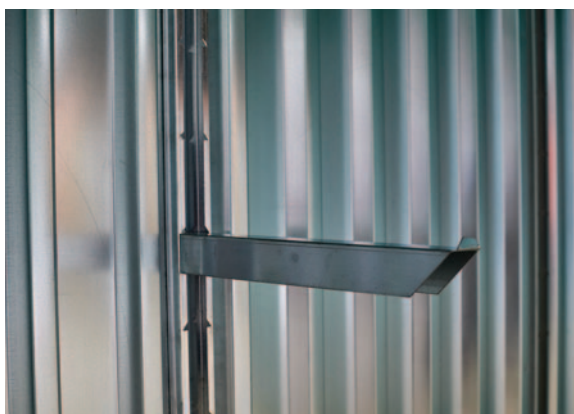

4.5 Now repeat the process for all other shelf uprights and shelf arms.



4.6 Finally you can now position the shelf onto the shelf arms (minimum of two).



4.7 Before adding any weight check that the shelf is sitting level and is secure.

Single Side, Full Length (Single-Tier)
Quickfind Code:1250
Single Side, Full Length (Two-Tier)
Quickfind Code:1254

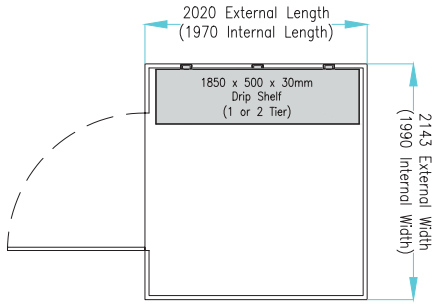

Both Sides, Full Length (Single-Tier)
Quickfind Code:1251
Both Sides, Full Length (Two-Tier)
Quickfind Code:1255

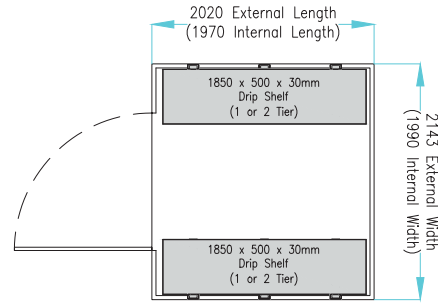

One Side & Rear End (Single-Tier)
Quickfind Code:1276
One Side & Rear End (Two-Tier)
Quickfind Code:1277

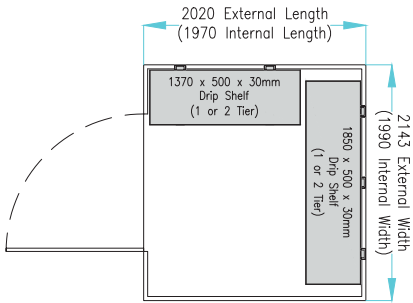

Both Sides & Rear End (Single-Tier)
Quickfind Code:1252
Both Sides & Rear End (Two-Tier)
Quickfind Code:1256

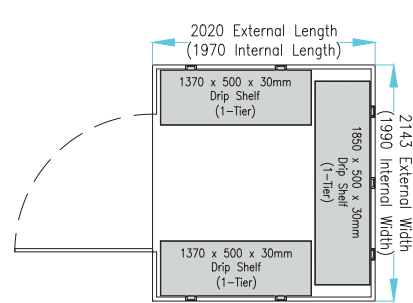

Single Side, Part Length (Single-Tier)
Quickfind Code:1253
Single Side, Part Length (Two-Tier)
Quickfind Code:1257

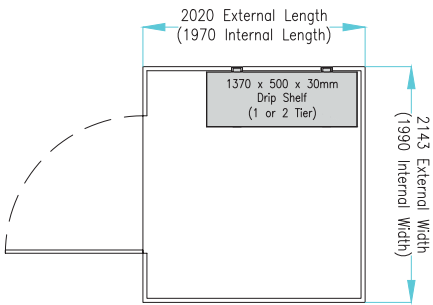

Both Sides, Part Length (Single-Tier)
Quickfind Code:1286
Both Sides, Part Length (Two-Tier)
Quickfind Code:1287

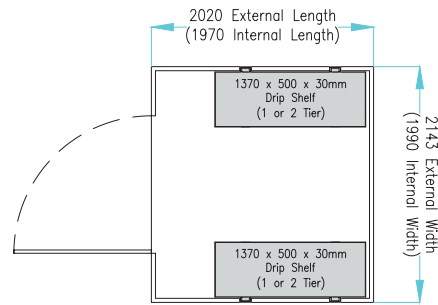

Rear End (Single-Tier)
Quickfind Code:1274
Rear End (Two-Tier)
Quickfind Code:1275

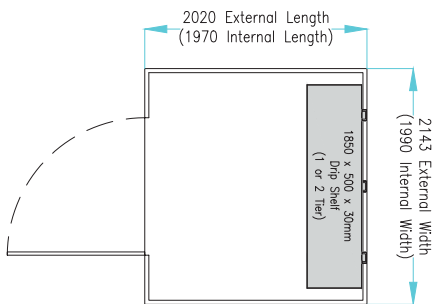

Shelving Details:

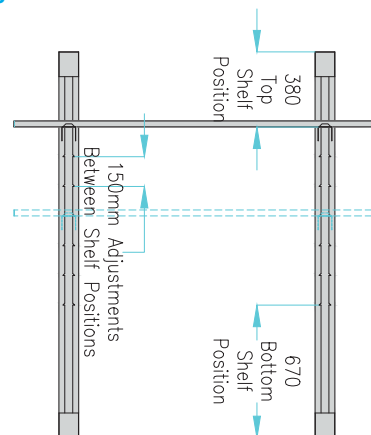

Please Note:

- Each arm is rated to hold 15kg per arm
- Each upright can support maximum of three drip shelves
- 150mm adjustment on shelf uprights

Single Side, Full Length (Single-Tier)
Quickfind Code:1258
Single Side, Full Length (Two-Tier)
Quickfind Code:1262

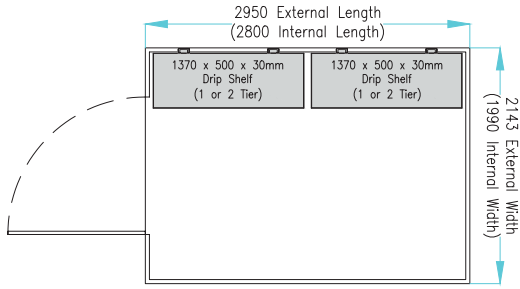

Both Sides, Full Length (Single-Tier)
Quickfind Code:1259
Both Sides, Full Length (Two-Tier)
Quickfind Code:1263

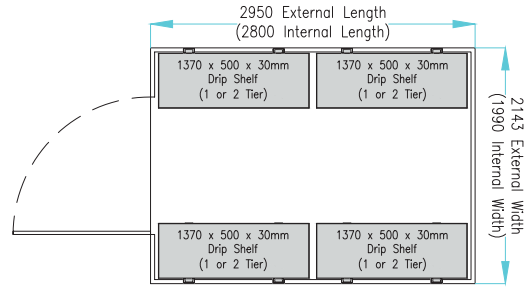

One Side & Rear End (Single-Tier)
Quickfind Code:1278
One Side & Rear End (Two-Tier)
Quickfind Code:1279

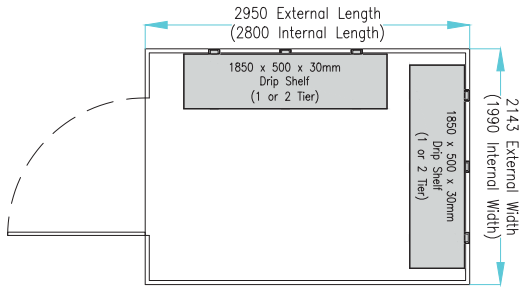

Both Sides & Rear End (Single-Tier)
Quickfind Code:1260
Both Sides & Rear End (Two-Tier)
Quickfind Code:1264

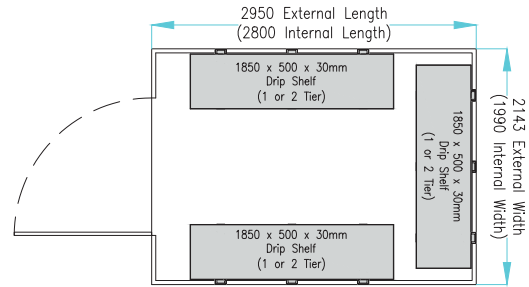

Single Side, Part Length (Single-Tier)
Quickfind Code:1261
Single Side, Part Length (Two-Tier)
Quickfind Code:1265

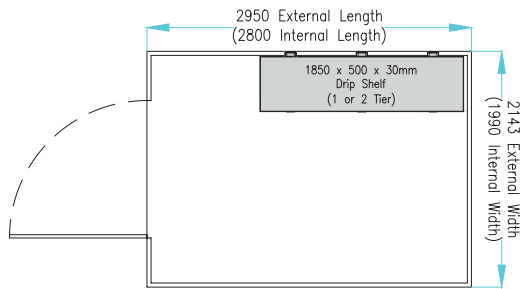

Both Sides, Part Length (Single-Tier)
Quickfind Code:1292
Both Sides, Part Length (Two-Tier)
Quickfind Code:1293

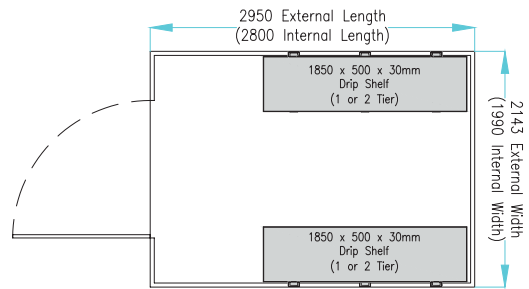

Rear End (Single-Tier)
Quickfind Code:1288
Rear End (Two-Tier)
Quickfind Code:1289

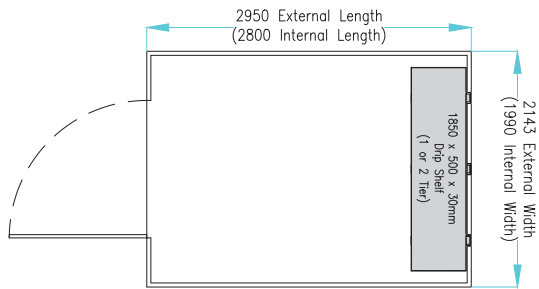

Shelving Details:

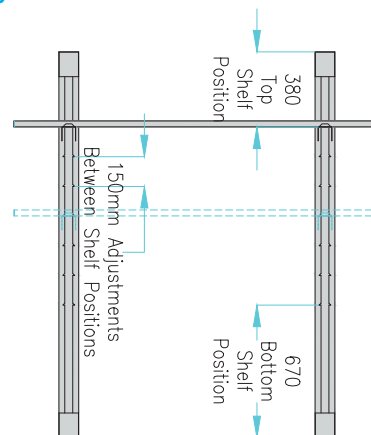

Please Note:

- Each arm is rated to hold 15kg per arm
- Each upright can support maximum of three drip shelves
- 150mm adjustment on shelf uprights

Single Side, Full Length (Single-Tier)
Quickfind Code:1266
Single Side, Full Length (Two-Tier)
Quickfind Code:1270

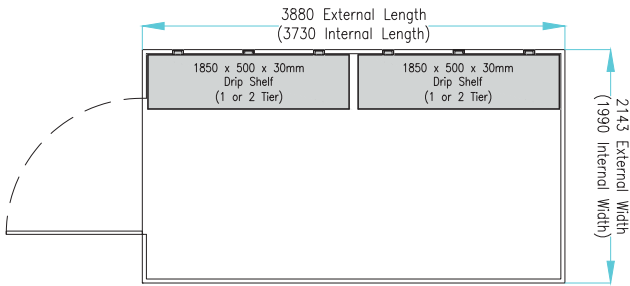

Both Sides & Rear End (Single-Tier)
Quickfind Code:1268
Both Sides & Rear End (Two-Tier)
Quickfind Code:1272

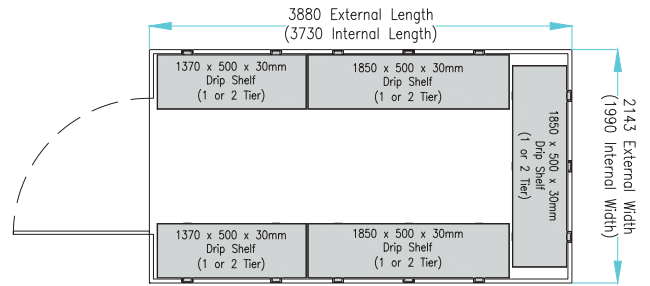

Both Sides, Full Length (Single-Tier)
Quickfind Code:1267
Both Sides, Full Length (Two-Tier)
Quickfind Code:1271

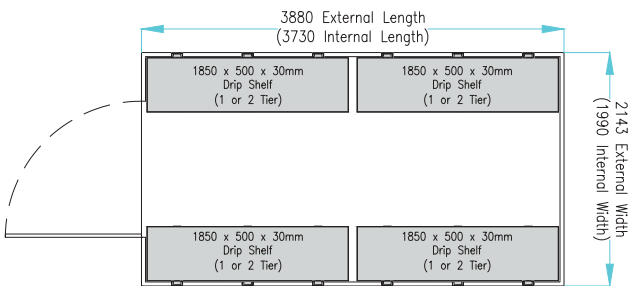

Single Side, Part Length (Single-Tier)
Quickfind Code:1269
Single Side, Part Length (Two-Tier)
Quickfind Code:1273

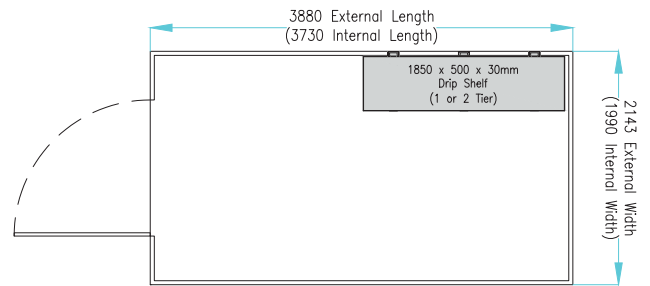

Single Side & Rear End (Single-Tier)
Quickfind Code:1280
Single Side & Rear End (Two-Tier)
Quickfind Code:1281

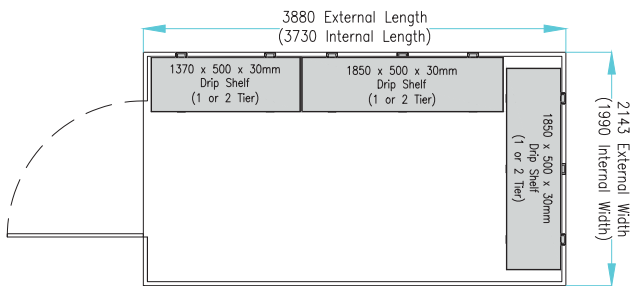

Rear End (Single-Tier)
Quickfind Code:1290
Rear End (Two-Tier)
Quickfind Code:1291

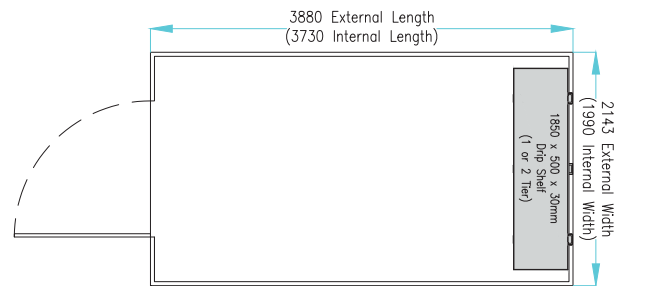

Please Note:

- Each arm is rated to hold 15kg per arm
- Each upright can support maximum of three drip shelves
- 150mm adjustment on shelf uprights

Shelving Details:

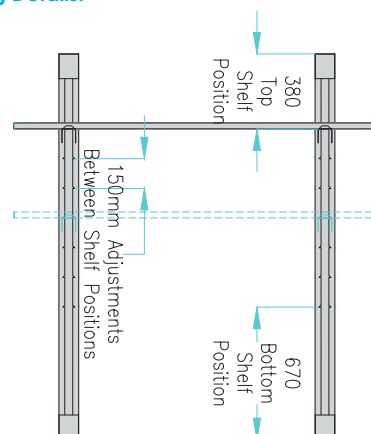

FLAT PACK STORE OPTIONAL EXTRAS 6M (2 X 3M) FLAT PACK STORE UNITS WITH SHELVING

Single Side, Full Length (Single-Tier)
Quickfind Code:1300
Single Side, Full Length (Two-Tier)
Quickfind Code:1304

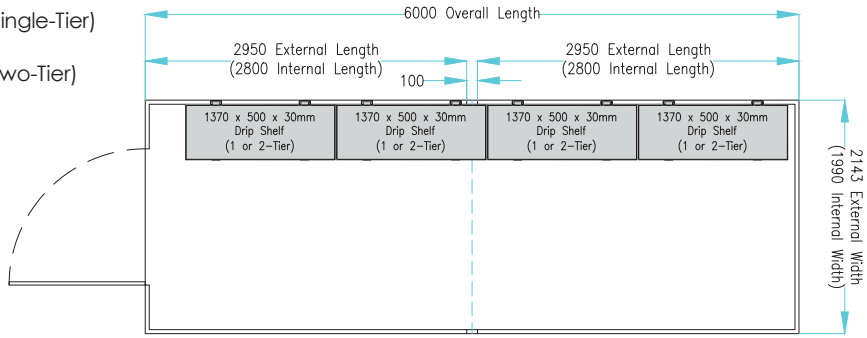

Both Sides & Rear End (Single-Tier)
Quickfind Code:1303
Both Sides & Rear End (Two-Tier)
Quickfind Code:1307

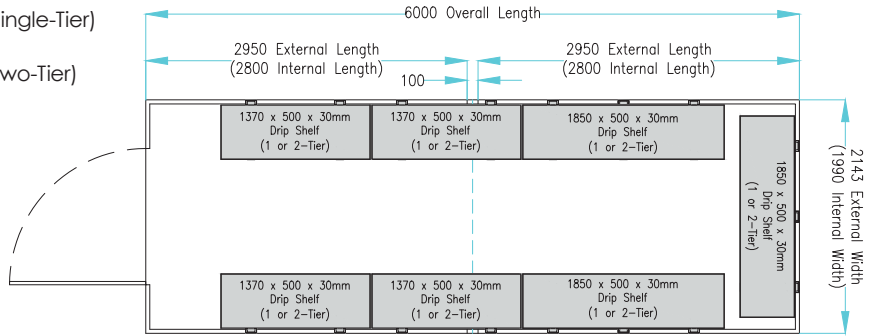

Both Sides, Full Length (Single-Tier)
Quickfind Code:1302
Both Sides, Full Length (Two-Tier)
Quickfind Code:1306

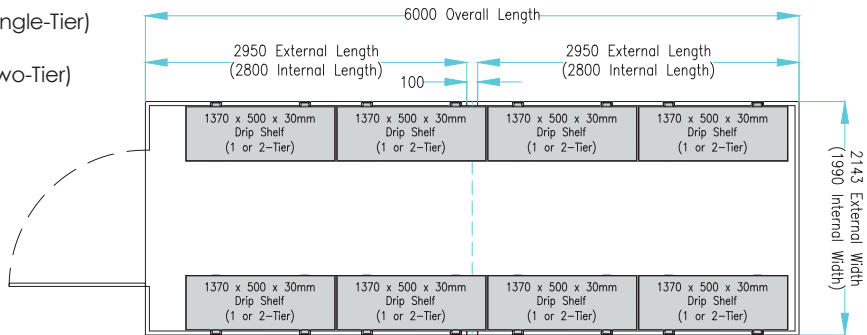

Single Side & Rear End (Single-Tier)
Quickfind Code:1301
Single Side & Rear End (Two-Tier)
Quickfind Code:1305

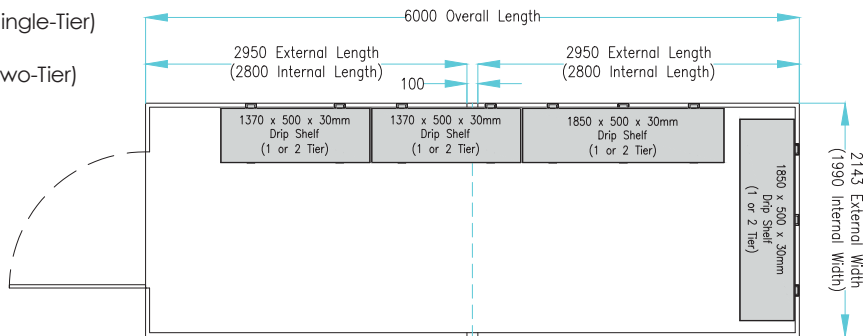

Rear End (Single-Tier)
Quickfind Code:1316
Rear End (Two-Tier)
Quickfind Code:1317

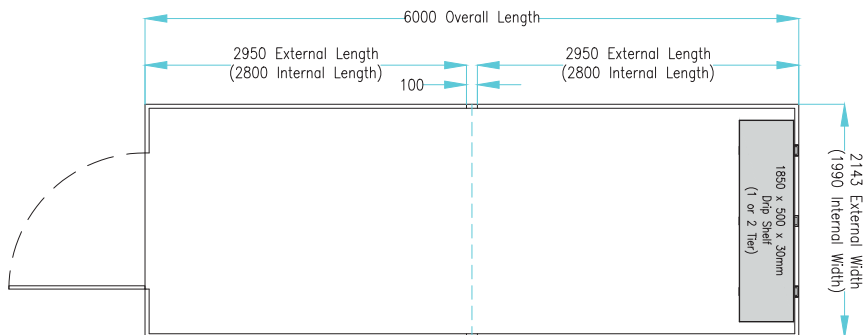

Please Note:

- Each arm is rated to hold 15kg per arm
- Each upright can support maximum of three drip shelves
- 150mm adjustment on shelf uprights

FLAT PACK STORE OPTIONAL EXTRAS 8M (2 X 4M) FLAT PACK STORE UNITS WITH SHELVING

Single Side, Full Length (Single-Tier)
Quickfind Code:1308
Single Side, Full Length (Two-Tier)
Quickfind Code:1312

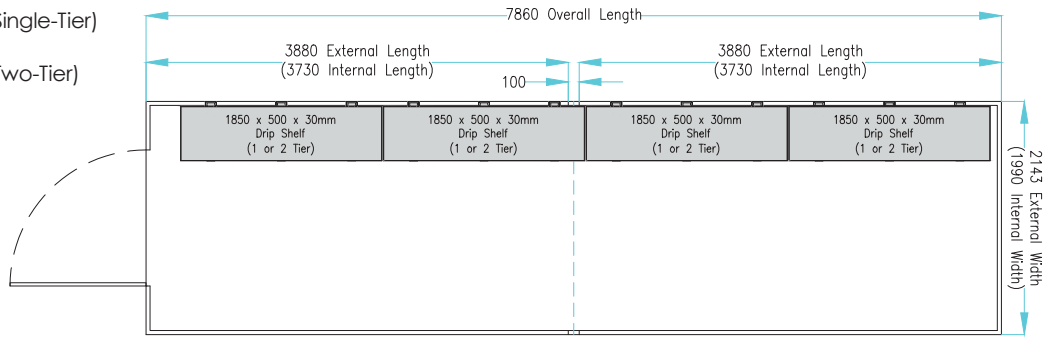

Both Sides & Rear End (Single-Tier)
Quickfind Code:1311
Both Sides & Rear End (Two-Tier)
Quickfind Code:1315

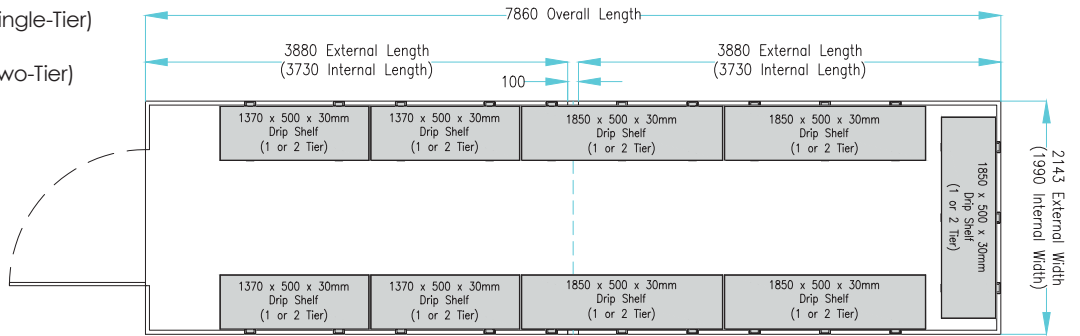

Both Sides, Full Length (Single-Tier)
Quickfind Code:1310
Both Sides, Full Length (Two-Tier)
Quickfind Code:1314

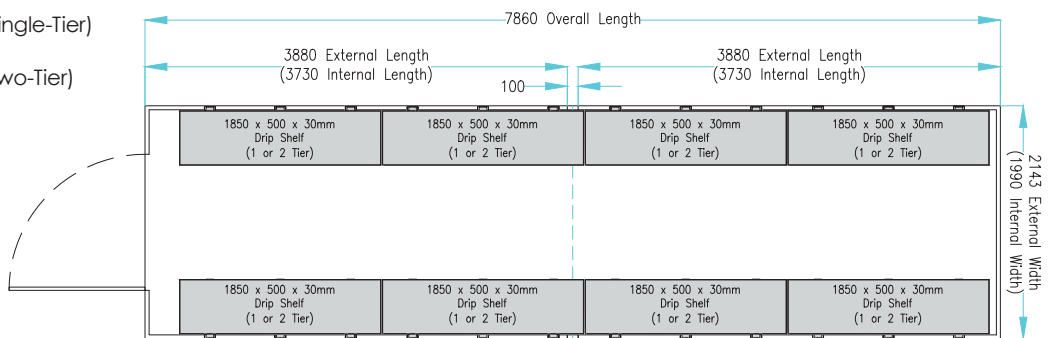

Single Side & Rear End (Single-Tier)
Quickfind Code:1309
Single Side & Rear End (Two-Tier)
Quickfind Code:1313

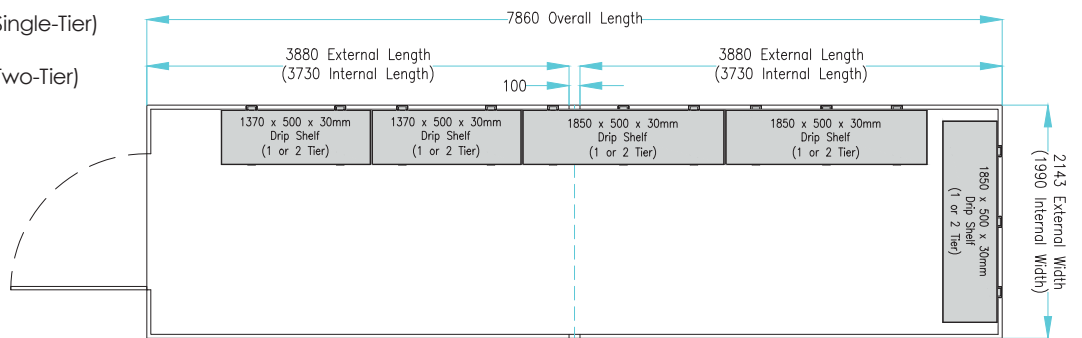

Rear End (Single-Tier)
Quickfind Code:1318
Rear End (Two-Tier)
Quickfind Code:1319

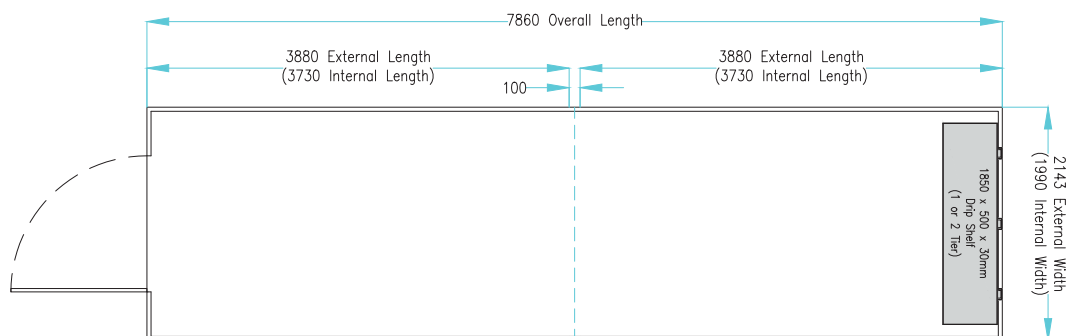

Please Note:

- Each arm is rated to hold 15kg per arm
- Each upright can support maximum of three drip shelves
- 150mm adjustment on shelf uprights

FLAT PACK STORE OPTIONAL EXTRAS 3M SIDE LINKED FLAT PACK STORE UNITS WITH SHELVING

3m x 4.2m side linked flat pack container shelving bundle, both sides, full length (two tier)
Quickfind Code: 1350

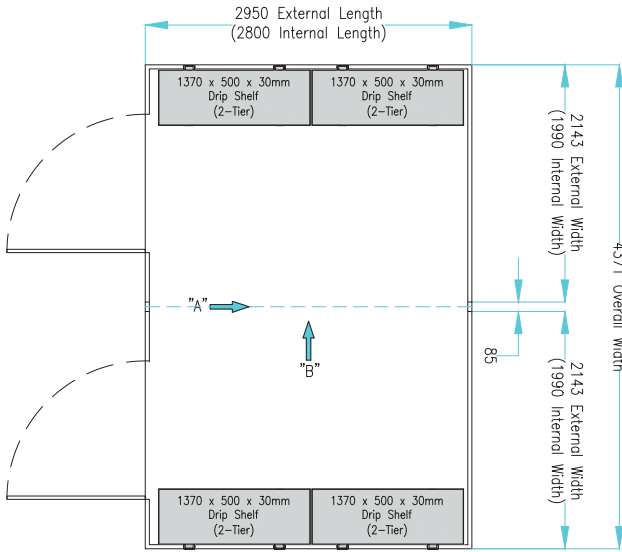

3m x 4.2m side linked flat pack container shelving bundle, both sides, part length (two tier)
Quickfind Code: 1351

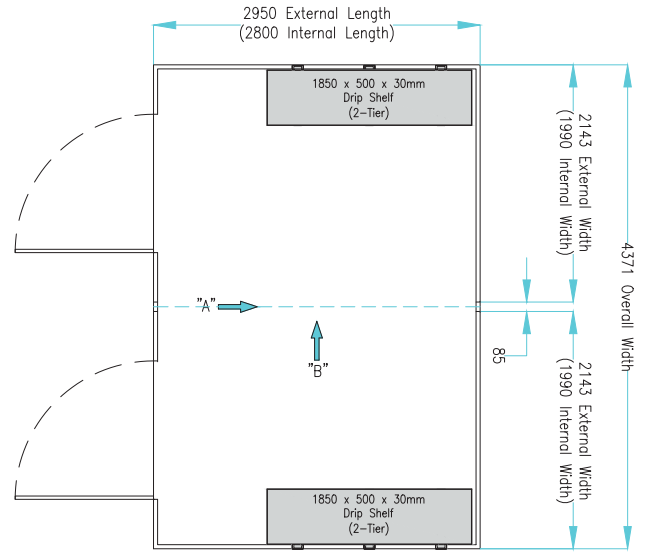

3m x 4.2m side linked flat pack container shelving bundle, rear shelf (single tier)
Quickfind Code: 1352

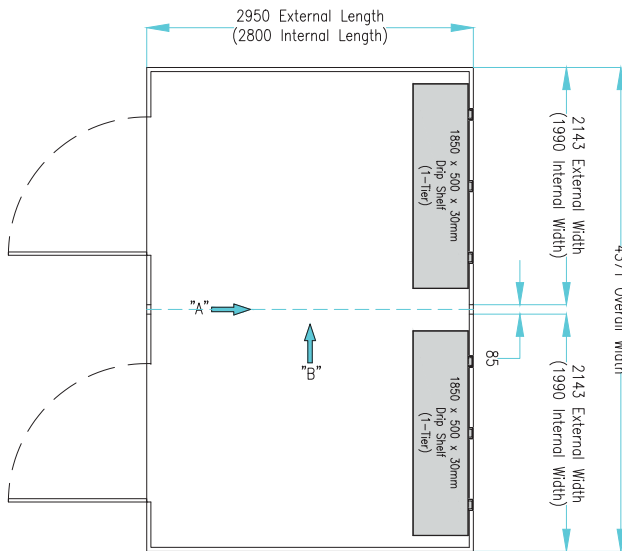

3m x 4.2m side linked flat pack container shelving bundle, rear shelf (two tier)
Quickfind Code: 1353

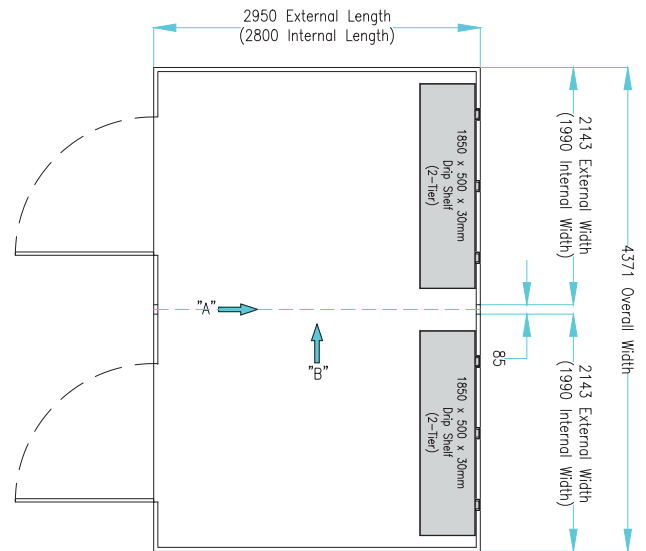

Please Note:

- Each arm is rated to hold 15kg per arm
- Each upright can support maximum of three drip shelves
- 150mm adjustment on shelf uprights

3m x 4.2m side linked flat pack container shelving bundle, single side, full length (single tier)
Quickfind Code: 1354

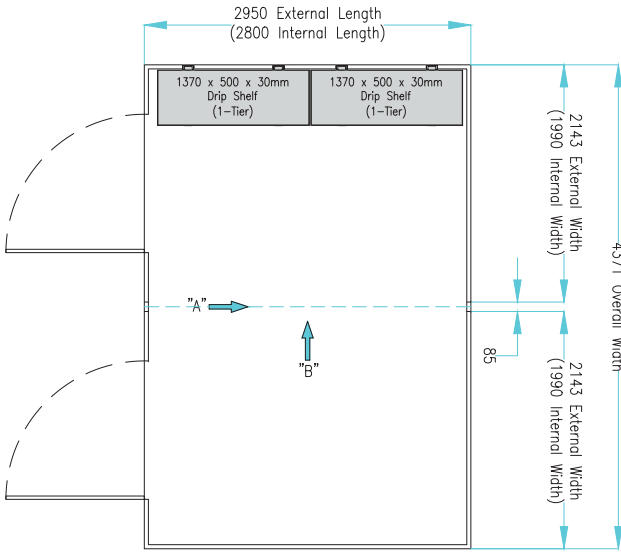

3m x 4.2m side linked flat pack container shelving bundle, single side, full length (two tier)
Quickfind Code: 1355

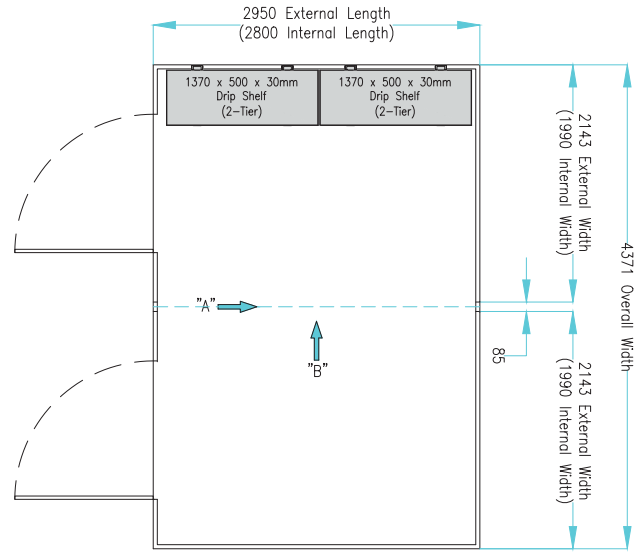

3m x 4.2m side linked flat pack container shelving bundle, single side, part length (single tier)
Quickfind Code: 1356

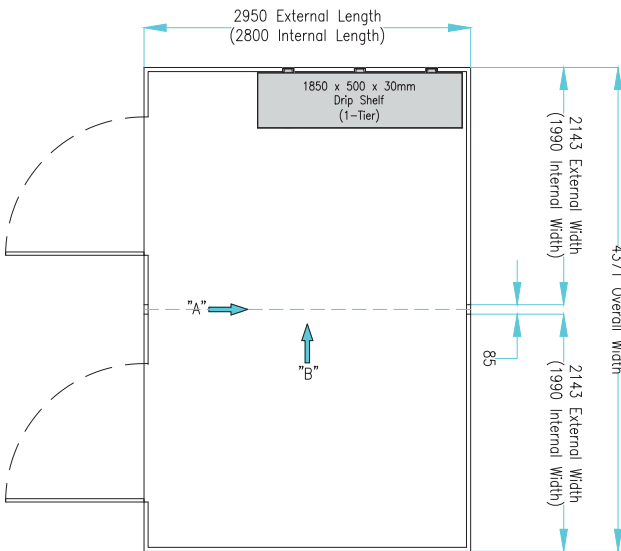

3m x 4.2m side linked flat pack container shelving bundle, single side, part length (two tier)
Quickfind Code: 1357

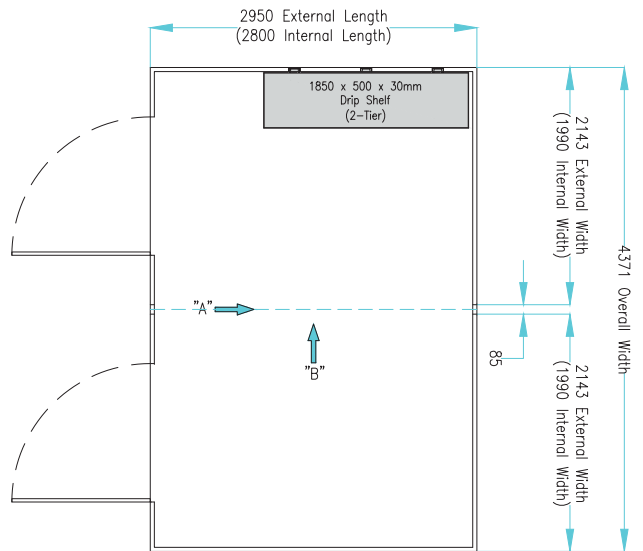

Please Note:

- Each arm is rated to hold 15kg per arm
- Each upright can support maximum of three drip shelves
- 150mm adjustment on shelf uprights

FLAT PACK STORE OPTIONAL EXTRAS 3M SIDE LINKED FLAT PACK STORE UNITS WITH SHELVING

3m x 4.2m side linked flat pack container shelving bundle, both sides, full length (single tier)
 Quickfind Code: 1358

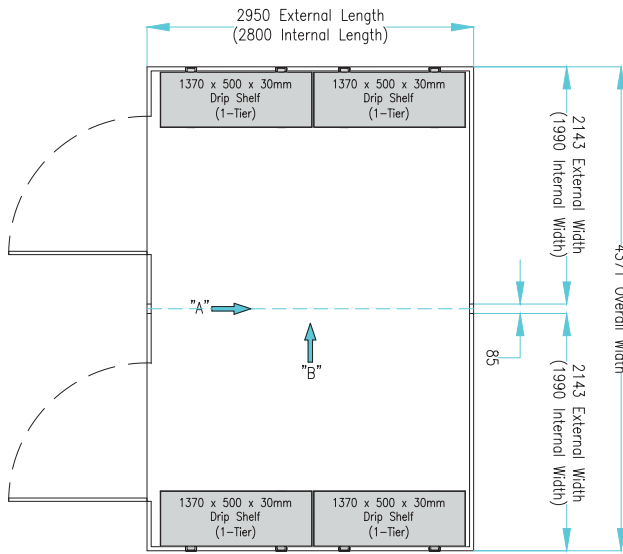

3m x 4.2m side linked flat pack container shelving bundle, both sides, part length (single tier)
 Quickfind Code: 1359

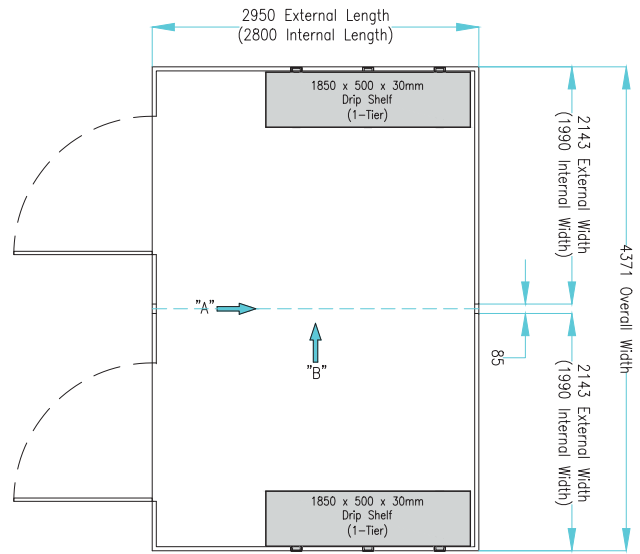

3m x 4.2m side linked flat pack container shelving bundle, both sides & rear (single tier)
 Quickfind Code: 1360

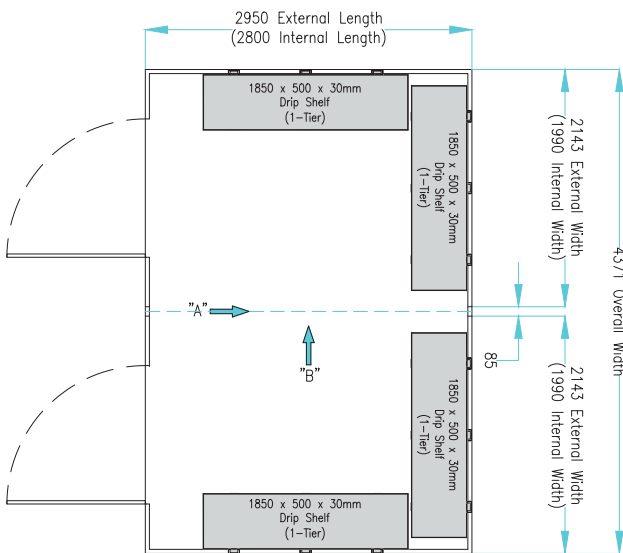

3m x 4.2m side linked flat pack container shelving bundle, both sides & rear (two tier)
 Quickfind Code: 1361

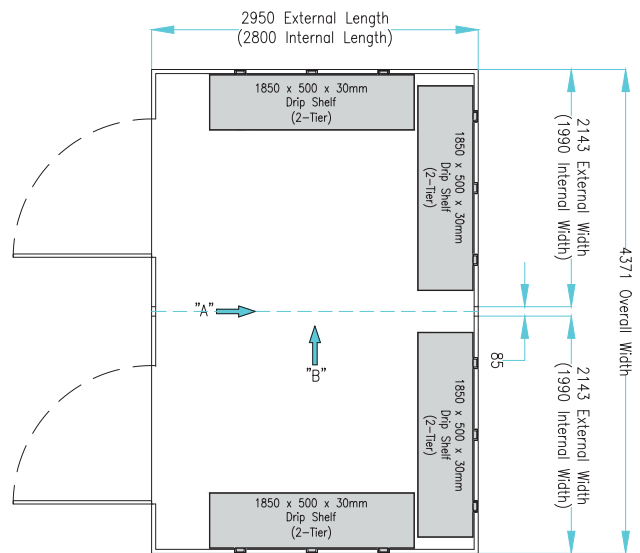

Please Note:

- Each arm is rated to hold 15kg per arm
- Each upright can support maximum of three drip shelves
- 150mm adjustment on shelf uprights

3m x 4.2m side linked flat pack container shelving bundle, one side & rear (single tier)
Quickfind Code: 1362

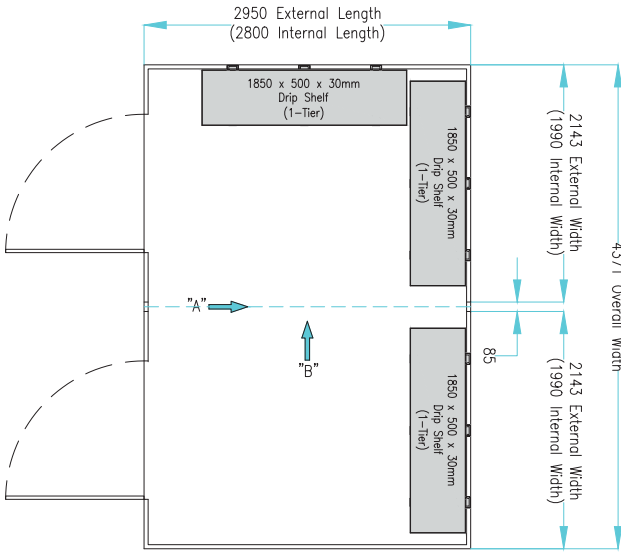

3m x 4.2m side linked flat pack container shelving bundle, one side & rear (two tier)
Quickfind Code: 1363

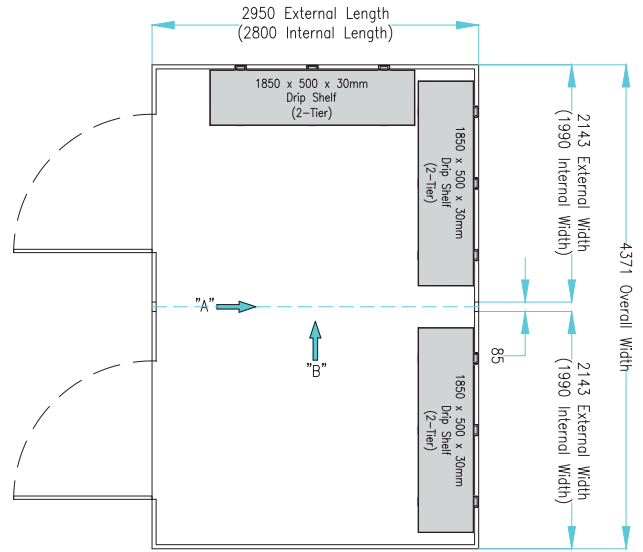

Please Note:

- Each arm is rated to hold 15kg per arm
- Each upright can support maximum of three drip shelves
- 150mm adjustment on shelf uprights

FLAT PACK STORE OPTIONAL EXTRAS 4M SIDE LINKED FLAT PACK STORE UNITS WITH SHELVING

4m x 4.2m side linked flat pack container shelving bundle, both sides (single tier)
Quickfind Code: 1364

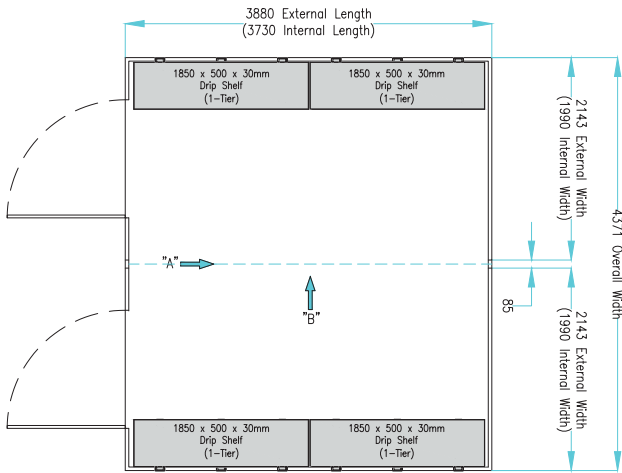

4m x 4.2m side linked flat pack container shelving bundle, both sides (two tier)
Quickfind Code: 1365

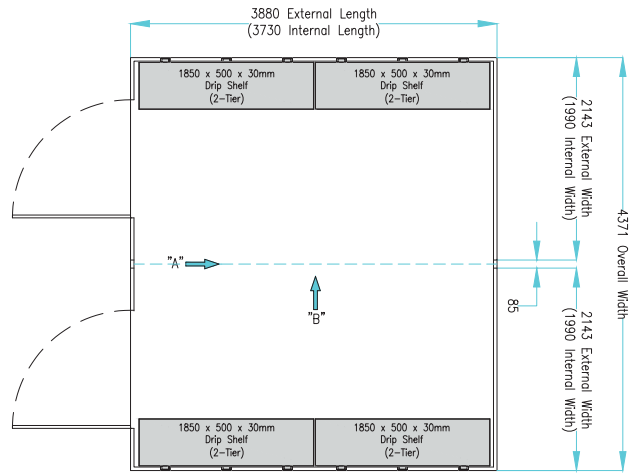

4m x 4.2m side linked flat pack container shelving bundle, both sides & rear (single tier)
Quickfind Code: 1366

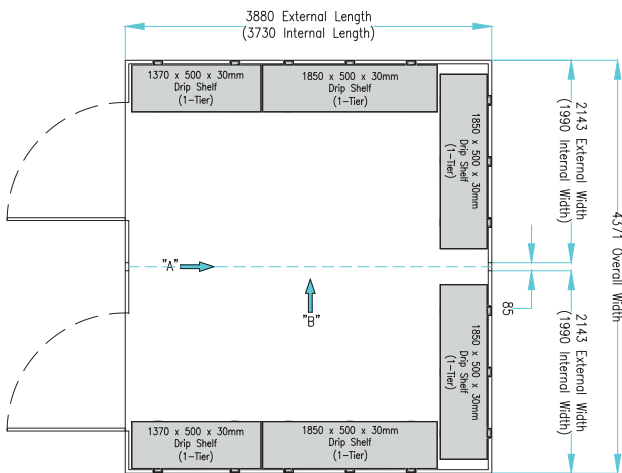

4m x 4.2m side linked flat pack container shelving bundle, both sides & rear (two tier)
Quickfind Code: 1367

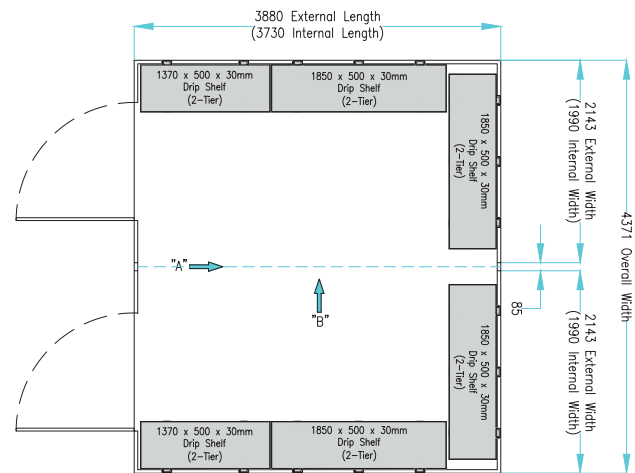

Please Note:

- Each arm is rated to hold 15kg per arm
- Each upright can support maximum of three drip shelves
- 150mm adjustment on shelf uprights

4m x 4.2m side linked flat pack container shelving bundle, half length (single tier)
Quickfind Code: 1368

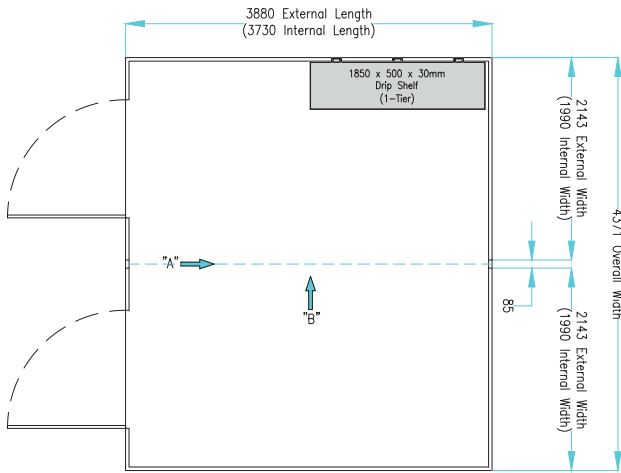

4m x 4.2m side linked flat pack container shelving bundle, half length (two tier)
Quickfind Code: 1369

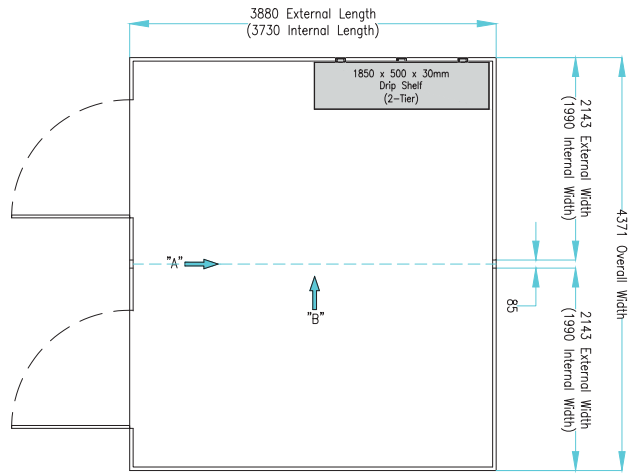

4m x 4.2m side linked flat pack container shelving bundle, rear shelf (single tier)
Quickfind Code: 1370

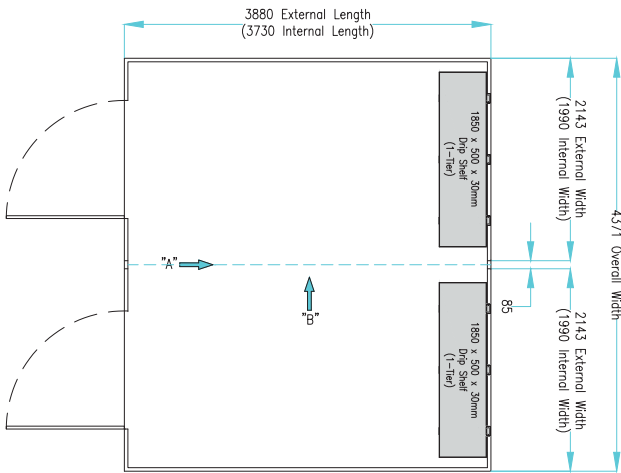

4m x 4.2m side linked flat pack container shelving bundle, rear shelf (two tier)
Quickfind Code: 1371

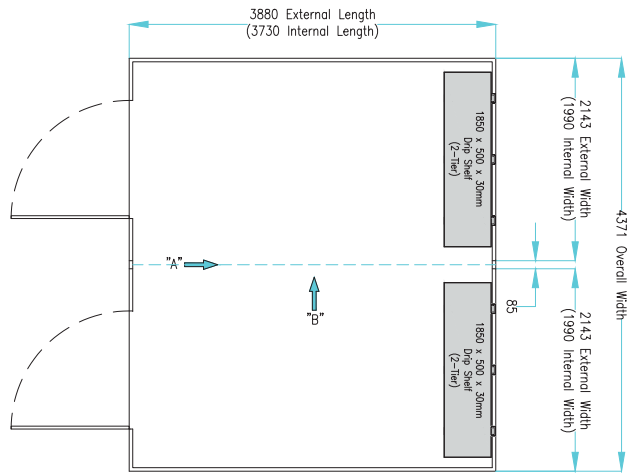

Please Note:

- Each arm is rated to hold 15kg per arm
- Each upright can support maximum of three drip shelves
- 150mm adjustment on shelf uprights

FLAT PACK STORE OPTIONAL EXTRAS 4M SIDE LINKED FLAT PACK STORE UNITS WITH SHELVING

4m x 4.2m side linked flat pack container shelving bundle, single side (single tier)
Quickfind Code: 1372

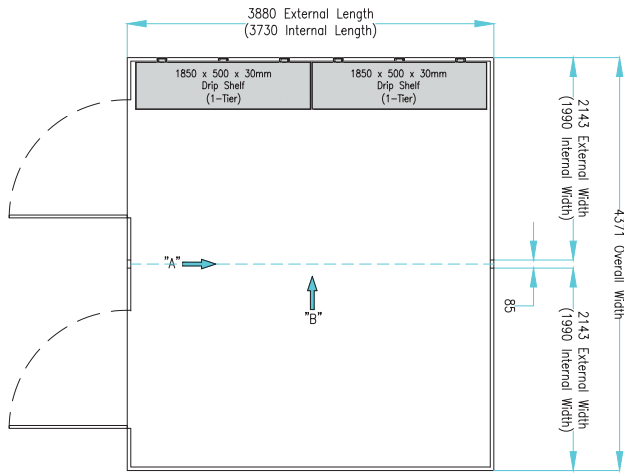

4m x 4.2m side linked flat pack container shelving bundle, single side (two tier)
Quickfind Code: 1373

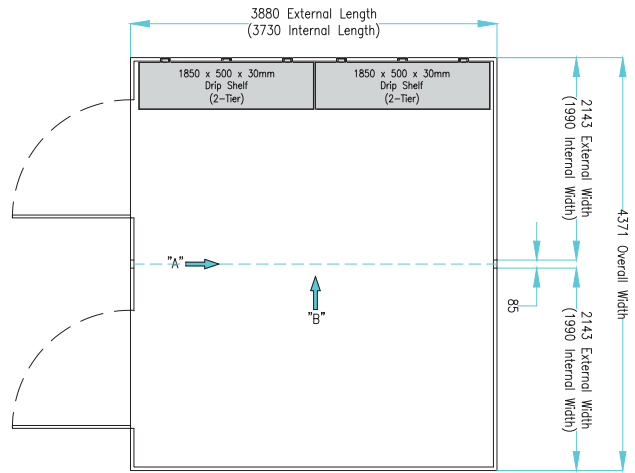

4m x 4.2m side linked flat pack container shelving bundle, one side & rear (single tier)
Quickfind Code: 1374

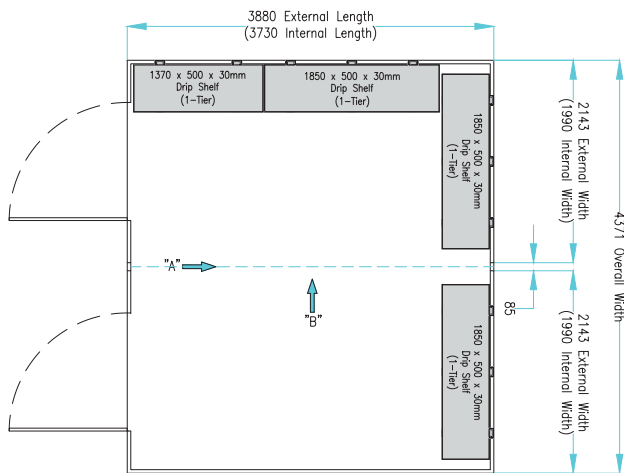

4m x 4.2m side linked flat pack container shelving bundle, one side & rear (two tier)
Quickfind Code: 1375

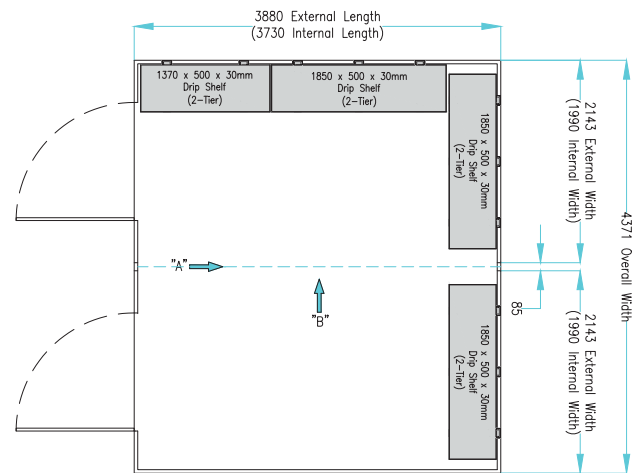

Please Note:

- Each arm is rated to hold 15kg per arm
- Each upright can support maximum of three drip shelves
- 150mm adjustment on shelf uprights